

Pool Cleaner User Manual

August 2019

Catalogue

1 Safety Warnings	1
2 Product Overview	2
2.1 Functions	2
2.2 Product Parameters.....	2
2.3 Pool Cleaner Parts.....	3
3 Packing List	4
4 Product Operation	5
4.1 Power Connection	5
4.2 Start Up Procedure.....	6
4.3 Proper Shut Down and Care.....	6
4.4 Remote Control.....	8
4.5 Water Joint.....	9
4.6 How to set the time, date and schedule the cleaning cycle	9
5 Maintenance	10
5.1 Impeller	10
5.2 Sponge Wheel.....	10
5.3 Drive Belt.....	14
5.4 Filter Bag.....	15
5.5 Retaining Board.....	15
5.7 Filter Cartridge	16
6 Troubleshooting and Warning Lights	17
7 Safety Checklist	20
8 Pool Cleaner-care and maintenance	21

1 Safety Warnings

Please read this manual carefully before using the Pool Cleaner.

-  Before performing maintenance or service on the Pool Cleaner please ensure the power is disconnected to avoid personal injury or property loss.
-  The Pool Cleaner is designed for use in swimming pools only. Any other use is prohibited and will void manufacturers' warranty.
-  Do not swim in the pool whilst the Pool Cleaner is in use in order to avoid personal injury.
-  Do not allow the Control Box to come in contact with water, and it is recommended to be placed in a shady, dry and ventilated area.
-  Do not cover the Control box whilst pool cleaner is in use to avoid overheating.
-  When in use, the Control Box and Caddy Cart must remain 3 meters away from the edge of the pool.
-  Do not use the Pool Cleaner if there is a chance of thunder storm to avoid personal injury.
-  Users are only permitted to perform maintenance described in this manual. Any tampering with the Motor Box or Control Box will void the warranty.
-  Ensure the Pool Cleaner is fully submerged before turning the Control Box on.
-  If the Pool Cleaner is not going to be used for a long time, make sure the Control box is disconnected, keep it clean and put it in a safe, dry and well-ventilated area.
-  If the Pool Cleaner stops working, please refer to section 6 "Troubleshooting". If you cannot find the root cause, please contact your local distributor.
-  The optimum working temperature for the Pool Cleaner is between 10°C and 35°C, avoid direct sunlight when not in use.
-  The Pool Cleaner is suitable for the swimming pools no deeper than 3 meters.
-  Lift the Pool Cleaner out of the water using the pool cleaner handles.
Do not lift the pool cleaner using the floating cable. Lifting via the cable voids warranty.
-  Do not use the pool cleaner more than 4hrs at a time (for commercial robot the limit is 8Hrs).
-  Ensure the electrical outlet is protected by a ground fault interrupter (GFI) or an earth leakage interrupter (ELI).
-  If the supply cord is damaged, it must be replaced by the manufacturer, its service agent or similarly qualified persons in order to avoid a hazard.

2 Product Overview

2.1 Functions

- ◇ Automatic Cleaning: the default mode is automatic.
- ◇ Overall Cleaning: the Pool Cleaner not only cleans the floor of your pool, but also cleans the wall. At the same time, the Pool Cleaner will filter water, and the dirt will be collected into Filter Bag.
- ◇ Manual Cleaning: the Remote Control can be used to clean specific areas immediately.
- ◇ Self Protection (out of water): Impeller decelerates to a stop in twenty five seconds if the Pool Cleaner senses it is no longer in water to prevent personal injury and protect the Water Pump.

2.2 Product Parameters

Input Voltage	110~240VAC, 50/60Hz
Rated Power	200W
Grade of Waterproof	Host: IP68
Control Box	A: IP56; B: IP23; C: IP23
Floating Cable Standard Length	15m/20m/30m/39m
Optimum Storage Temperature	0~40℃
Optimum Working Temperature	10~35℃

2.3 Pool Cleaner Parts

Main Body Options



Control Box Options



A



B



C

Filter Net



Caddy



200D Caddy



Base Plate



Remote Control



3 Packing List

Serial Number	Part Name	Quantity	Remarks
1	Unit Body	1	Host
2	Impeller Cover	1	
3	Control Box	1	
4	User Manual	1	
5	Warranty Card	1	
6	Certificate of Quality	1	

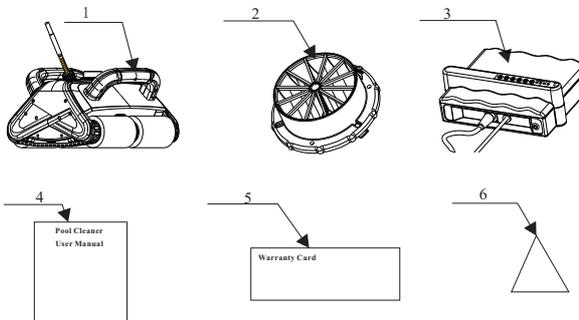

4 Product Operation

4.1 Power Connection

Please connect the Floating Cable to the Cable Socket of Control Box (see Pic. 4.1.1), then connect the Control Box to an outside AC power of 110v/240v 50/60Hz (see Pic.4.1.2). For the complete connection guide please refer Pic.4.1.3.

Notices: Do not allow the Control Box to come in contact with water. Please ensure the Control Box is kept in a shady, dry&well ventilated area Refer Page 1. Safety Warnings.

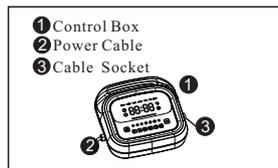

(Pic.4.1.1)

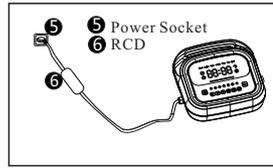

(Pic.4.1.2)

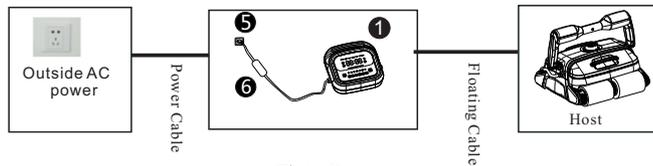

(Pic.4.1.3)

NOTE: Do not connect using an extension power cable.

4.2 Start Up Procedure

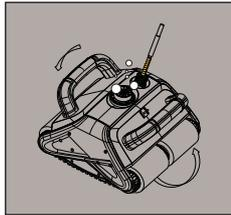

(Pic.4.2.1)

(1) When placing the pool cleaner in the pool: you must wobble the pool cleaner according to Pic.4.2.1. This ensures the air inside is released so when you put the pool cleaner in the water it will automatically sink to the bottom of the pool when the sponge wheels are saturated.

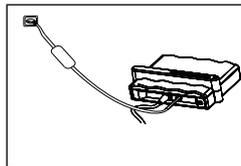

(Pic.4.2.2)

(2) Start : If the Control Box cord with an RCD, please press "RESET" button firstly, then press the "⊕" or "⊖" button.

If using the Control Box "C" for the pool cleaner, please press the Rocker Switch button on the Control Box.

4.3 Proper Shut Down and Care

- Use the handles to remove the pool cleaner from the water.
Lift via the floating cable will void the warranty.
- Remove Impeller cover a check for debris around the shaft.
- Remove the base plate and clean the filter bag.
- Remove floating cable from the Control Box, and wind it up neatly, and store on the pool cleaner or bracket provided on the caddy.



④ Floating Cable
⑥ Handle

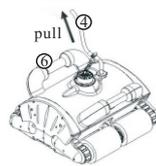

(Pic.4.3.1)

(1) To Shut Down Pool Cleaner: press the "⊕" / "⊖" on the Control Box once the pool cleaner finishes working, pull the Floating Cable slowly until the Handle emerges from the water (Pic.4.3.1), and then pull the pool cleaner out of the pool by its Handle.

NOTE:

- 1.If the Control Box wire has an RCD, please press the TEST button on the RCD after press the "⊕" or "⊖".
- 2.If using the Control Box "C" for the pool cleaner, please press the Rocker Switch button on the Control Box.

(2) Clean pool cleaner: Remove impeller cover and then invert the pool cleaner gently onto the floor, unlock the Latch on the Base Plate (Pic4.3.1) and remove the Filter Bag from Base Plate, clean the Filter Bag (Pic.4.3.2). Once clean the Filter Bag on its frame, reassemble the Base Plate and put it back into the pool cleaner after the Filter Bag is dry.

(Note: when re-fitting the Filter Bag to the Base Plate, please ensure the long sides of the Filter Bag are smooth to ensure an easy fit into the base of the pool cleaner.)

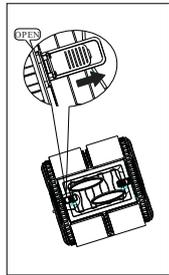

(Pic.4.3.1)

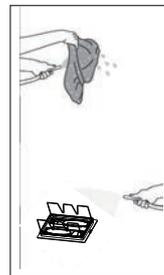
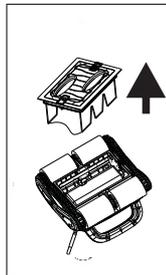

(Pic.4.3.2)

(3) Pool Cleaner Storage:

When the Pool Cleaner is clean, disconnect the floating cable reel it in hand-over-hand and place on the Pool Cleaner, **then store the Pool Cleaner in a dry, well-ventilated area.** If you have the Caddy, please put the Pool Cleaner & Floating Cable on to the Caddy Cart, details please refer Pic.4.3.3.

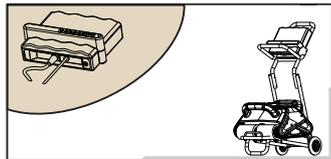

(Pic.4.3.3)

4.4 Remote control

The Remote Control (Pic.4.5.1) includes:

- On/Off Power Button 
- LED Light Indicator
- Direction Button
- Timer Button 
- Floor and Wall/Floor Only Cleaning 
- Time Cycle Button 
- Enter Button 

On/Off Power Button: 

Turn on or turn off Pool Cleaner.

Direction Button:

Control Pool Cleaner's movement Backward , Left Rotation  and Right Rotation .

Timer Button 

1. Press the button "", then the indicator light "" will start flashing (on the Control Box).
2. Press button "" and "" to select the pool cleaner working time (the max time subjects to the actual pool cleaner).
3. Press the button "" to confirm after setting.

Floor and wall/ Floor Only Cleaning 

Clean the "Floor and Wall" press . Return to "Floor Only Cleaning" press .

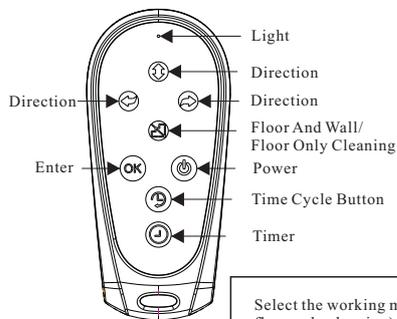

(pic.4.4.1)

Select the working mode (floor and wall or floor only cleaning) using the button  and press the "" to confirm.

4.5 Water Joint



(Pic.4.5.1)

Step 1

※ Insert Water Joint into Pool Cleaner. (Pic.4.5.1)

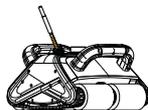

(Pic.4.5.2)

Step 2

※ Screw down the Lock Nut clockwise. (Pic.4.5.2)



(Pic.4.5.3)

Step 3

※ Fix the Floating Cable. (Pic.4.5.3)

4.6 How to set the time, date and schedule the cleaning cycle.



(Pic.4.6.1)

4.6.1 Setting the time

1. Press the button “”, then indicator light “” will flash.
2. Press the button “” to select the time: . Press the button “” or “” to select the date. (when the light “” is flashing, it means the pool cleaner will work everyday of the week.) To confirm the setting, press the “” button.

4.6.2 Timer

1. Press the button “”, then indicator light “” will flash.
2. Press button “” to select the pool cleaner working time (the max time subject to the actual pool cleaner).
3. Press the “” button to confirm after setting.

4.6.3 Setting the date

1. Press and hold the “” button for 20 sec until the indicator light “” starts flashing.
2. Press “” to set the year.
3. Press the “” to enter the month.
4. Press “” to change the month.
5. Press the “” to enter the date.
6. Press “” to change the date.
7. Fourth press the “” to enter the time.
8. Press the “” to change the time.
9. Press “” to confirm the settings.

4.6.4 Select the working mode (floor and wall or floor only cleaning) use the button “” and press the “” to confirm.

5 Maintenance

5.1 Impeller

※ Replace the Impeller if the old one gets worn or damaged.

Impeller Cover



(Pic.5.1.1)



Step 1

※ Rotate Impeller Cover clockwise to remove from the pool cleaner Rover.
(Pic.5.1.1)

Step 2

※ Use a Phillips Head Screw Driver to remove the bolt in the Impeller according to the diagram.(Pic.5.1.2)



(Pic.5.1.2)

Step 3

※ Replace the new Impeller.

5.2 Sponge Wheel

※ Replace the Sponge Wheels if they are badly worn or broken.

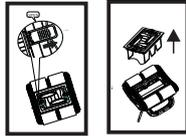

(Pic.5.2.1)

Step 1

※ Invert the Pool Cleaner on the floor, remove the Base Plate(push Latch to unlock the Base Plate).(Pic.5.2.1)

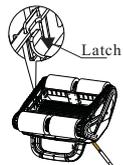

(Pic.5.2.2)

Step 2

※ Remove the Filter Net from the Pool Cleaner while pressing the Latch according to the diagram.(Pic.5.2.2)

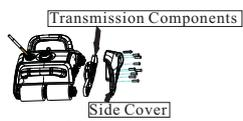
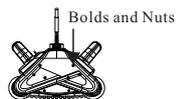

(Pic.5.2.3)

Step 3

Using a Phillips Head Screwdriver and 7mm ring spanner undo the six bolts and nuts on the Side Cover to remove the Side Cover. (Pic.5.2.3)

【if the pool cleaner's Filter cartridge is on the top of pool cleaner, please remove the Filter cartridges from the pool cleaner, and then using a Phillips head screwdriver and a 7mm ring spanner, undo the six bolts and nuts on the Side Cover to remove the Side Cover and Transmission Components.】

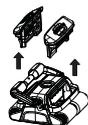

Remove the Filter cartridge from the pool cleaner.

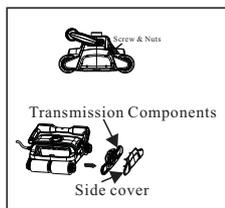

(Pic.5.2.4)

Using a Phillips head screwdriver and a 7mm ring spanner, undo the six bolts and nuts on the Side Cover to remove the Side Cover and Transmission Components.

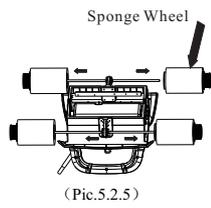

Step 4
※ Remove the Sponge Wheel. (Pic.5.2.5)



Step 5
※ Slide the old Sponge Wheels off,
and replace with new Sponge Wheels.
(Pic.5.2.6)

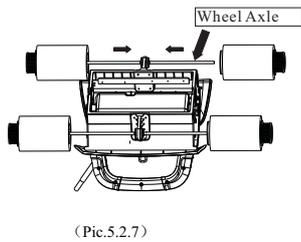

Step 6
※ Assemble the Sponge Wheel to the Axle.
(Pic.5.2.7)

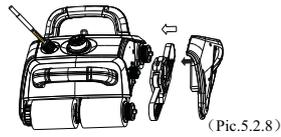

Step 7
 ※Reassemble the Transmission Components and Side Covers to the body of the unit.(Pic.5.2.8)
 If the pool cleaner is used the four small belt please reference the picture from pic.5.2.9 to pic.5.2.13.

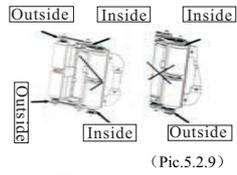

First assemble the Sponge Wheel to the Axle and put the new Synchronous Belt to the Drive Wheel & Roller to assemble the Synchronous.(Pic.5.2.9)

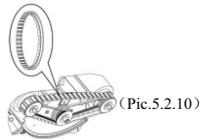

Second assemble the Drive Belt on the Roller Wheel.(Pic.5.2.10)



Third assemble Drive Wheel Baffle Plate to the Drive Wheel.(Pic.5.2.11)

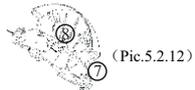

Fourth put the Drive Wheel Sleeve and Roller Wheel Sleeve to Side Covers.(Pic.5.2.12)

- ⑦ Roller Wheel Sleeve
- ⑧ Drive Wheel Sleeve

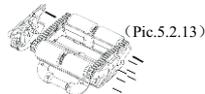

Fifth put the side covers to pool cleaner and fasten it with bolts&nuts.(Pic.5.2.13)

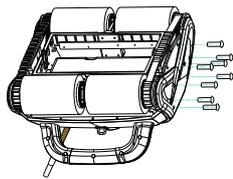

(Pic.5.2.14)

Step 8
 ※ Fasten the Transmission Components and Side Covers to the body of the unit using the nuts and bolts. (pic.5. 2. 14)

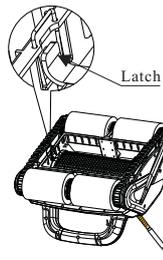

(Pic.5.2.15)

Step 9
 ※ Put the Filter Net into the pool cleaner, press down on the Filter net until the Latch locks into the Bracket. (Pic.5.2.15)

5.3 Drive Belt

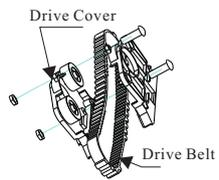

Pic.5.3.1

Replace the Drive Belt if they are broken.(Pic 5.3. 1)

※ Using a Phillips Head Screwdriver Spanner undo the bolts and nuts, then remove the Drive Cover and replace the Drive Belt. (Pic.5.3.1)



Pic.5.4.1 Filter Bag is full

5.4 Filter Bag

When the Filter Bag is dirty as shown in pic. 5.4.1 or if the Filter Bag has been damaged, please refer to chapter 4.4 to replace Filter Bag.

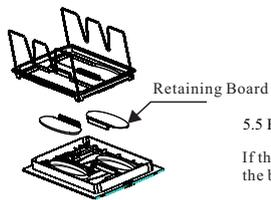

Pic.5.5.1 Retaining Board

5.5 Retaining boards

If the retaining board is damaged, please unassemble the base plate and replace.

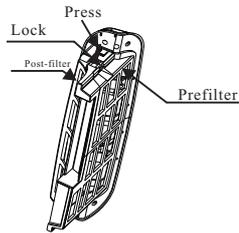

(pic.5.6.1)

5.6 Filter cartridge

Step 1:

Press the Lock of the Post-filter and separate the Pre-filter.



(pic.5.6.2)

Step 2:

A. Remove the filter bag from the cartridge, turn inside out and clean.
B. Wash the filter Cartridge using the water spray or firm brush.

5.7 Commercial pool cleaner maintenance

All commercial pool cleaners to be inspected every 24 months or 500 Hours Water Pump Seals are to be replaced every 24 months or 500 hours. Please contact your nearest service Center to arrange this.

Commercial pool cleaners			
Date sold	/.	/.	
Service Date	Number of Hours	Minimum action	Service Center name
	500	Replace pump seals, check body for damage.	
	1000	Replace pump seals, replace coupling blocks, replace impeller check drive Belt tension and sponge wheels.	
	1500	Replace pump seals, check all 1000 hour items, replace all bearings, check drive shaft and drive wheel condition.	
	2000	Replace pump seals, replace coupling blocks replace impeller.	
	2500	Replace pump seals, check body for damage.	
	3000	Replace pump seals, check all 1000 hour items, Replace all bearings, check drive shaft and drive wheel condition.	

6 Troubleshooting and Warning Lights

Common fault	Reason	Solution	Remarks
Pool Cleaner doesn't work	The Socket is not plugged in	Plug in the Power Lead	Please turn off the power before you perform any maintenance on the Pool Cleaner.
	Connection is wrong	Check the connection	
Weak Pumping	Impeller is jammed or dirty	Clean the Impeller	
	Impeller is damaged	Replace the Impeller	
	Filter Bag is full	Clean the Filter Bag	
Pool Cleaner is turning to one side when it moves	Synchronous Belt is loosen or broken at one side	Replace the Synchronous Belt	
	The Filter Bag is full, broken or blocked	Clean Filter Bag	
Pool Cleaner will not climbs wall	Filter Bag is full	Clean the Filter Bag	
	Synchronous Belt is loosen or broken	Replace the Synchronous Belt	
	Sponge Wheel wear	Replace the Sponge wheel	
	Axis Sleeves wear	Replace Axis Sleeves	
Pool Cleaner will not sink to the bottom of the pool	The Sponge Wheels are not saturated.	You must hold cleaner in water and make sure Sponge Wheel soak enough, normal time is about 5 -15 minutes	
	It has air inside the machine	Invert Pool Cleaner and make sure air is released, then re-invert.	
Dirt is coming through the Impeller Cover.	Belt of Filter Bag is loosen or broken. Dirt is too fine for the Filter Bag	Replace broken Filter Bag with a finer grade Filter Bag.	

Note: The power MUST BE DISCONNECTED from the Control Box prior to conducting any maintenance on the Pool Cleaner. Contact your local distributor, or place of purchase for problems not covered in Trouble Shooting Guide.

B



Indicator Light	Failure	Solution
Green light flashing	The pool cleaner has stopped due to lack of water	Return the pool cleaner to deeper water and restart.
Yellow light flashing	The Motor Pump inside the pool cleaner has over heated	Contact the supplier for support.
Blue light flashing	The pool cleaner is upside down	Turn the pool cleaner over, and restart using the remote control or power switch.
Blue and green lights flashing	The walking (drive wheel) motors are over loaded	1. Check the walking motors, Drive tracks and tacking belts for debris or damage. 2. Clear bebris or replace parts parts and restart the pool cleaner.
Blue, green and yellow lights flashing	The water pump is over loaded	1. Turn the pool cleaner off, check the impeller for debris, or damage. 2. Clear or replace impeller, then restart the pool cleaner.
green and yellow lights flashing	The Motor Pump(2) inside the pool cleaner has over heated	Contact the supplier for support.

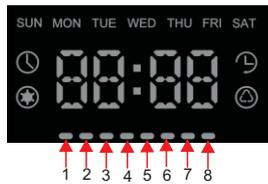

light flashing	Failure	Solution
Light 1 and code 1	The pool cleaner is out of water	Return the pool cleaner to deeper water and restart. Maybe the impeller is broken, replace with new impeller.
Light 2 and code 2	The Motor Pump is over heated	Contact the supplier for support.
Light 3 and code 7	Abnormal voltage	Restart , please contact the supplier for support if there is any problem.
Light 4 and code 4	The pool cleaner is upside down	Turn the pool cleaner over, and restart using the remote control or power swich.
Light 5 and code 5	The walking motors are over loaded	1.Check the walking motors, drive tracks and tacking belts for debris or damage. 2.Clear bebris or replace parts and restart the pool cleaner.
Light 6 and code 6	The Control Box is over heated	When the Control Box cools down, if the pool cleaner can't restart, please contact the supplier for support.
Light 7 and code 8	Signal connection problem	Reconnect the floating cable or contact the supplier for support.
Light 8 and code 10	The water pump is over loaded	1. Turn the pool cleaner off, check the impeller for debris, or damage. 2. Clear or replace impeller, then restart the pool cleaner.
Light 1 , 2 and 3 and code 9	Abnormal voltage of Control Box	Contact the supplier for support.
Light 1 and 2 and code 11	Pool cleaner can't climb walls	1. Filter Cartridge is full.Clean the Filter Cartridge.
		2. Sponge wheel is broken. Replace with a new sponge wheel.
		3. The pool cleaner is stuck.
		4. PCB has failed. Contact the supplier for support.
Light 1 and 8 and code 12	Running motor no load	Contact the supplier for support.

7 Safety Checklist

- ◇ Please shut down the pool cleaner according to chapter 4.4 when you have finished cleaning the pool.
- ◇ Please inspect and clean the impeller & Guide Vane according to chapter 5.1, after use.
- ◇ If you are not going to use the pool cleaner for an extended period of time, make sure pool cleaner & Control Box is turned off, and store it in a dry, shady & well ventilated area, with a temperature range between 0-40°C.
- ◇ If you want to reuse pool cleaner after it has been stored for an extended period of time, please check the pool cleaner for visual damage (cracks & rust) prior to use. Once you are sure pool cleaner is free from damage, test run it, and if it performs as expected, then allow it to run automatically.
- ◇ If the pool cleaner requires repair, please contact your local distributor.

8 Pool Cleaner-care and maintenance

To ensure the longevity of the robot, follow the care and maintenance instructions located in the User Guide

User Guide Summary Points:

1. Fix Control Box to the caddy.
2. Ensure the caddy cart is secured to a fixed object.
3. Do not cover the Control Box when in operation.
4. Protect the Control Box from weather.
5. Remove the robot from pool after each use.
6. Do not use the cable to lift the robot from the pool.
7. Remove impeller covers and debris from impeller shafts.
8. Clean filter bag/s(occasionally put through washing machine)
9. Refit impeller covers.
10. Store robot on the caddy(sponge wheels resting on the caddy frame)
11. Store robot and caddy in a dry, shaded, well ventilated area.