

## Installation & Operating Guide



## SALT & MINERAL CHLORINATOR



\*See Page 26

# CONTENTS

| <b>Section</b>                                  | <b>Page #</b> |
|---|---------------|
| 1. Important Warnings/Safety Instructions ..... | 3 - 4         |
| 2. Packaging Contents .....                     | 4             |
| 3. Tools Needed .....                           | 4             |
| 4. Preparing the Pool .....                     | 5             |
| 5. Recommended Water Balancing .....            | 6             |
| 6. Installation Diagram .....                   | 7             |
| 7. Installing the Chlorinator Power Pack .....  | 8             |
| 8. Installing the Cell .....                    | 8             |
| 9. Control Panel Operation .....                | 9             |
| 10. Initial Start-up .....                      | 10            |
| 11. The Main Screen .....                       | 11            |
| 12. Shortcut Buttons .....                      | 11            |
| 12.1 Shortcut Button: Power/Mode .....          | 11            |
| 12.2 Shortcut Button: Chlor Boost .....         | 11 - 12       |
| 12.3 Shortcut Button: Winter/Blanket .....      | 12            |
| 12.4 Shortcut Button: Clock/Timer .....         | 12 - 13       |
| 12.5 Shortcut Button: Salt Test .....           | 13 - 14       |
| 12.6 Shortcut Button: Backwash .....            | 14 - 15       |
| 13. Main Menu .....                             | 15            |
| 13.1 Main Menu: Backwash .....                  | 15            |
| 13.2 Main Menu: Brightness .....                | 15            |
| 13.3 Main Menu: Cell Cleaning .....             | 15            |
| 13.4 Main Menu: Chlor Boost .....               | 16            |
| 13.5 Main Menu: Chlor Setting .....             | 16            |
| 13.6 Main Menu: Clock/Timer .....               | 16            |
| 13.7 Main Menu: Contrast .....                  | 16            |
| 13.8 Main Menu: Power/Mode .....                | 16            |
| 13.9 Main Menu: Pump Setting .....              | 16            |
| 13.10 Main Menu: Salt Test .....                | 17            |
| 13.11 Main Menu: Service Menu .....             | 17            |
| 13.12 Main Menu: Spa Mode .....                 | 17            |
| 13.13 Main Menu: Winter/Blanket .....           | 17            |
| 13.14 Main Menu: pH Control Mode .....          | 17 - 18       |
| 14. Chlorinator Maintenance .....               | 19            |
| 15. Troubleshooting .....                       | 20 - 22       |
| 16. Schematics .....                            | 23 - 25       |
| 17. Chlorine Production Specifications .....    | 25            |
| 18. Technical Support .....                     | 26            |
| 19. Warranty .....                              | 26 - 27       |
| 20. Product Registration .....                  | 27            |

Congratulations on your recent purchase of your Neptune Digital Salt and Mineral Chlorinator. Thank you for supporting Pool Pro Products.

Please take a moment to read through the entire manual before installing your new unit. Your chlorinator must be installed and operated as specified. While every effort has been made to ensure that the information contained in this guide is accurate and complete, no liability can be accepted for any errors or omissions. Pool Pro reserves the right to change the specifications of the hardware and software described herein at any time without prior notice.

Please remember that your Neptune Chlorinator is not designed to chemically maintain your pool water and keep it balanced, but rather to produce chlorine from a mild salt solution within the water. We encourage regular water testing, balancing and correction if, and when required to maintain the recommended balanced levels of your pool water. This is a vital part of a complete maintenance program and will ensure trouble free performance as well as a healthy and sparkling clean pool.

The Neptune Digital Chlorinator models are reverse polarity units designed to automatically change direction every 4-16 hours (depending on your setting). This change of polarity causes the calcium to dislodge and keep the cell plates clean. Occasional cleaning of the electrode plates may still be necessary.

Thank you again for choosing a Neptune Digital Chlorinator. We wish you many happy years of swimming in your crystal-clear pool.

## 1. IMPORTANT WARNINGS/SAFETY INSTRUCTIONS



This manual contains important information about the installation, operation, and safe use of this product. This information should be given to the owner and/or operator of this equipment. When installing and using this electrical equipment, basic safety precautions should always be followed. Failure to follow safety warnings and instructions in this manual can result in serious injury and/or damage to your equipment. Read and follow all warning notices and instructions which are included in this manual.

- The Power Supply internally contains live components. There is a danger of electric shock if opened. If the power cord is damaged then it should be replaced by the manufacturer, their agent or similar.
- To reduce the risk of injury, do not permit young children to use this product unless they have been trained by the person responsible for their safety and they acknowledge their ability to use such equipment. To reduce the risk of accidents or incidents, service on the unit should only be performed by your local pool Professional.
- When mixing acid with water, ALWAYS ADD ACID TO WATER. NEVER ADD WATER TO ACID.
- DO NOT PLUG UNIT IN IF CARTON HAS BEEN WET.
- GAS BUILDUP CAN OCCUR WITH IMPROPER WIRING: To reduce the risk of

personal injury the Power Pack is designed so that the Electrolytic Cell will only receive power when the pool pump is on. Otherwise, dangerous chlorine gas build-up can occur. If the pump is not installed to the AC Socket (pump outlet) on the Power Pack, then the installer must ensure that the Electrolytic Cell is never energized when the pool pump is OFF, or water is not flowing through the unit.

- Read and keep your user manual in a safe place.
- Increase chlorine production when temperature goes up.
- Use Stabiliser to stabilise chlorine in the swimming pool.
- Ideal salt levels range between 3000-3500ppm (parts per million). Salt levels below 3000ppm and above 4000ppm may damage equipment and void any warranty.
- Decrease production when temperature goes down - see Section 12.3 WINTER/ BLANKET MODE.
- Disclaimer: Information in this guide is intended to provide general information on a particular subject(s) in good faith and is not an exhaustive treatment of such subject(s). Its use is beyond the control of the author, contributor, publishers, and distributors and should not be relied upon without consulting your local Professional for comprehensive advice. This guide includes subject(s) that should only be performed by or under the direction and advice of your local Professional and under no circumstances should the guide be used as a substitute for such professionals. No representations or warranties are made that the content, advice, and recommendations in this guide are current, free from errors or omissions, or appropriate for the user's circumstances or abilities. No liability is accepted for any loss suffered as a result of any user's reliance on such content.

## 2. PACKAGING CONTENTS

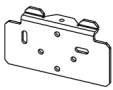

Wall mounting bracket

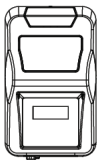

Power pack

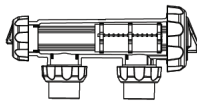

Cell housing with unions



2 x 50/40 reducing bushes



2 x green wall plugs with screws



User manual

## 3. TOOLS NEEDED



Drill with 6mm drill bit



Basic PVC fittings

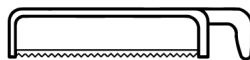

Hacksaw



PVC primer & PVC cement "Type P" for pressure pipes



No.2 Phillips head screwdriver

## 4. PREPARING THE POOL

Check your salt levels in your pool before starting your unit. **See Section 12.5 to perform a SALT TEST.**

**Salt levels should be 3000-4000ppm (ideally 3500ppm). Salt levels below 3000ppm and above 4500ppm may damage equipment and void any warranty. To achieve this TDS with minerals, you may need to add 20-30% more product to the pool water. Contact your local pool Professional for further assistance.**

Salt levels above 5000ppm on these models may overload the unit and cause excessive heat and void your warranty.

For all new pool installations please seek advice from your pool builder or your local pool Professional before adding salt, as some new surfaces request no salt to be added when initially completed.

**NEVER ADD SALT/MINERALS DIRECTLY TO THE SKIMMER BOX. This high concentration of either salt or minerals will pass through your filtration, pump and other pool equipment. Remove automatic pool cleaner from the pool before adding salt or other chemicals.**

### HANDY TIPS:

The colder the water the lower your output, but this does not mean you need more salt. There will always be less chlorine demand in colder water.

**For salt only:** We recommend adding 3.5kg of pool salt per 1000 litres of pool water.

**For minerals/magnesium chloride:** Allow an extra 20-30% of the product to achieve the correct TDS for these types of salts. Follow the instructions on the product packaging and/or consult your local pool Professional.

Salt and minerals should always be added to the shallow end of the pool and allowed to dissolve. Do not let the salt/minerals settle on the floor of the pool as it may cause damage to the surface. Use your pool brush to mix the salt/minerals into the water.

Running the pump will mix the water and help the salt/minerals to dissolve.

Only run the pump in the first 8-12 hours (ensure the cell is switched off) to allow the salt/minerals to dissolve.

By pressing [SALT TEST] a salt measurement is taken, and a total TDS reading is displayed. The ideal TDS reading should be an LCD display of "OK", approximately 3000ppm – 4000ppm. If "HIGH" is displayed, the salt level is above 4500ppm and the salt level is too high, and if "LOW" is displayed the salt is below 1000ppm and we suggest taking a sample to your local pool Professional for a more accurate result and further assistance.

# 5. RECOMMENDED WATER BALANCING

Consult your local Pool Pro Professional to correctly balance your pool water. Follow instructions on the packaging of each chemical. Always add chemicals to water, never add water to chemicals.

|                         | Recommended Values                                    | To Increase Value                                    | To Decrease Value  | Test Frequency |
|-------------------------|---|--|--|----------------|
| pH                      | Concrete: 7.2 – 7.6 Fibreglass/Vinyl: 7.0 – 7.2       | Add Pool Pro pH Increaser (Soda Ash)                 | Add Pool Pro Hydrochloric Acid   | Weekly         |
| Free Chlorine           | 1 – 3ppm  | Increase the chlorine output on the chlorinator unit | Add Pool Pro Chlorine Out and decrease the chlorine output on the chlorinator unit | Weekly         |
| T.A. (Total Alkalinity) | Concrete: 80 – 150ppm Fibreglass/Vinyl: 80 – 120ppm   | Add Pool Pro pH Buffer                               | Add Pool Pro Hydrochloric Acid   | Fortnightly    |
| Calcium Hardness        | Concrete: 250 – 300ppm Fibreglass/Vinyl: 150 – 200ppm | Add Pool Pro Hardness Raiser                         | Add Pool Pro Calcium Remover   | Fortnightly    |
| Stabiliser              | 30 – 60ppm  | Add Pool Pro Stabiliser or Pool Pro Rapid Stabiliser | Contact your Pool Pro Professional for advice                                      | Fortnightly    |
| Salt                    | 3000 – 3500ppm  | Add Pool Pro Ultrafine or Premium Pool Salt          | Partially empty the pool and refill it   | Fortnightly    |

This is a guide only, does not constitute and should not be used as an alternative to specific professional advice. Pool Pro and The POPS Group Pty Ltd accept no liability for any damage, loss or harm associated with the use of this guide.





## 6. INSTALLATION DIAGRAM

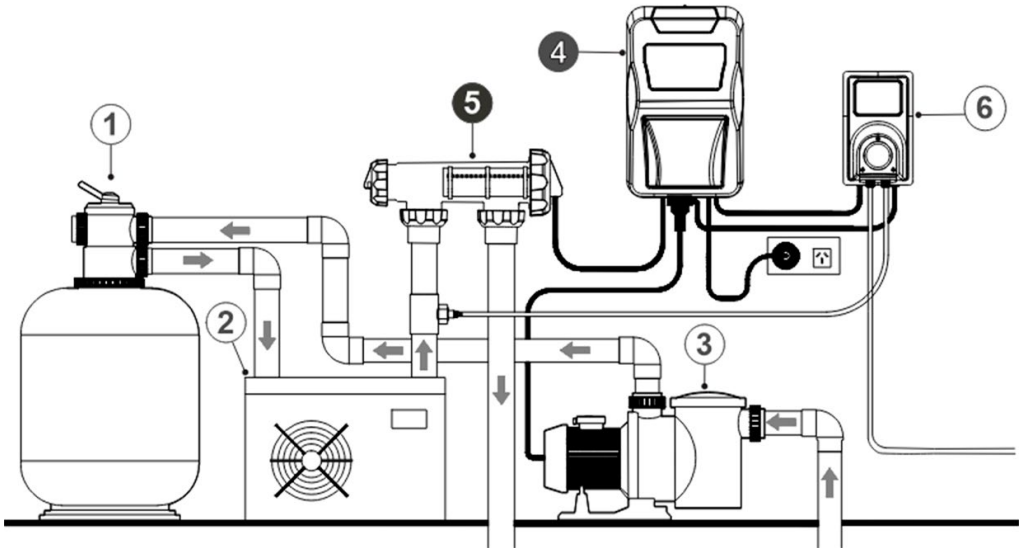

| Ref # | Item        |
|-------|-------------|
| 1     | Pool Filter |
| 2     | Heat Pump   |

| Ref # | Item        |
|-------|-------------|
| 3     | Pool Pump   |
| 4     | Chlorinator |

| Ref # | Item          |
|-------|---------------|
| 5     | Cell Housing  |
| 6     | pH Controller |



### IMPORTANT NOTES

The pump rating must not exceed 8amps.

Saltwater may damage electrical components in the Power Pack.

**WARNING:** We DO NOT recommend the use of valves on the inlet or outlet of the cell housing. If you do use a valve, then it is important to ensure that the valve cannot deadhead (lock closed) while the pump is running. It is the installer's responsibility to ensure some form of flow control is installed in this instance and it disables the pump.

ALWAYS ensure that pipe work and equipment do not allow gases generated from the Cell to collect and build up in any part of the installation.

It is RECOMMENDED that the Cell Housing be installed horizontally to create a natural gas trap that acts as a safety device. Installation in any other way may cause explosion, injury or death if the installer does not allow for gas removal. A venturi pipe is installed/ molded within the Cell Housing design to eliminate any possible gas build up, although it is always recommended to ensure proper installation to eliminate this from happening.

The Cell Housing must be installed in the RETURN pipework to the pool. It must always be installed after the filter, gas heater, solar heating, or heat pump.

DO NOT apply priming fluid to the Cell Housing, it is not needed and may react with the plastic.

## 7. INSTALLING THE CHLORINATOR POWER PACK

The Neptune Digital Salt and Mineral Chlorinator has an Ingress Protection Rating of IP23 enabling it to be installed outdoors. Regulations require that the Power Pack shall be installed outside the pool zone. The Power Pack shall be installed according to AS/NZS 3000 wiring rules.

The Power Pack should be installed in a well-ventilated position ideally away from sunlight and rain to prolong life and at least 1m above ground to prevent run off water entry.

Ensure that the Power Pack is not stored near chemicals, fertilisers or in a closed unventilated shed with similar products as the fumes will cause excessive corrosion and damage to the internals of the Power Pack and may void warranty.

When mounting the Power Pack on a post it is recommended to install a flat panel at least the same size to act as a waterproof backing plate.

Mount the Power Pack with the Mounting Bracket, Green Plugs and Screws provided.

The Power Pack should be mounted no further than 1.5m from the Chlorinator Cell for ease of operation.

## 8. INSTALLING THE CELL

Connect the Cell Housing horizontally in the return line to the pool (use reducing bushes supplied if 40mm PVC pipe) using high pressure PVC glue. The Cell Housing can be mounted vertically but provision must be made for a gas trap.

Direction of water flow through the Cell Housing is not critical although we do recommend entry from the closed end of the Cell Housing and exit from the end closest to the Cell Locking Ring. The reason is to cause less water hammer over time on the cell plates.

Check that the O-Ring is clean, greased with silicone grease (DO NOT use petroleum-based jelly) and securely located in the Cell Housing.

Ensure Cell Locking Ring is firmly tightened by hand (DO NOT use a tool to tighten).

Connect the lead from the Cell Electrode to the Cell Plug under the Power Pack ensuring a firm snap lock connection.

Plug the Power Pack's 3 pin plug into a suitable weatherproof RCD protected 10amp outlet and then plug the pump into the 3 pin AC Socket located at the bottom of the Power Pack.



# 9. CONTROL PANEL OPERATION

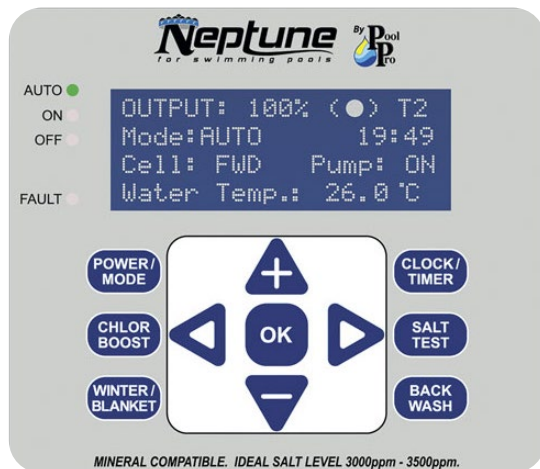

## IMPORTANT NOTES

After 60 seconds of inactivity in any display, the display will return to the Main Screen.







After 10 minutes of inactivity in any display, the LCD screen will dim.  
Simply press any button on the control panel to wake the screen.

| BUTTON | FUNCTION  |
|--------|---|
|        | Sets the chlorinator's operating mode between AUTO, ON and OFF. This is displayed on the LCD screen next to "Mode".   |
|        | Sets the chlorinator and pump to operate for 8 hours at 100% output. Defaults to 8 hours but can be modified.   |
|        | Reduces the chlorine output to 50%. Defaults to 50% but can be modified.  |
|        | Sets the clock (time of day) and the timer (chlorinator operating times).   |
|        | Measures the salt level of the pool water. Also shows the salt value.   |
|        | Runs a backwash process to clean the media inside the pool filter system.   |
|        | - Enters the Main Menu if pressed when the LCD screen is displaying the Main Screen (see section "Main Screen" on page 9).<br>- Saves any changes made to the settings. |
|        | - Scrolls up any menus.<br>- Adjusts values of any options selected.  |
|        | - Scrolls down any menus.<br>- Adjusts values of any options selected.  |
|        | - Exits menus.<br>- Returns to the previous screen.   |
|        | Used during service by qualified Pool Pro Professionals.  |





## 10. INITIAL START-UP

On initial startup of your Neptune chlorinator, the screen will run through a start-up sequence. Please wait until "START UP CLOCK SET" is displayed.







### SETTING THE CLOCK (time of day)

1. "START UP CLOCK SET" will display on the LCD screen.
2. "00" will flash for Hours. Press  or  to change the hour. Press  to save.
3. "00" will flash for Minutes. Press  or  to change the minutes. Press  to save.





### SETTING THE TIMER / RUN PERIOD (daily run times of the chlorinator)

1. "START UP RUN PERIODS" will display on the LCD screen. "2 CYCLES/DAY" will flash.
2. Press  or  to scroll through the cycles.  
Select from the following cycles for your chlorinator to operate:  
(a) "2 CYCLES/DAY" = 6am - 10am and 4pm - 8pm  
(b) "1 CYCLE AM" = 8am - 4pm  
(c) "1 CYCLE PM" = 8pm - 4am
3. Press  to save or press  to exit without saving. If these cycle times are not suitable, you can change them in the Clock/Timer function – see page 11-12.

### SETTING UP THE POOL SIZE

1. "START UP INFORMATION" will display on the LCD screen. The litre quantity for "POOL SIZE" will flash.
2. Press  or  to change the litre quantity by 1,000L increments, hold  or  to change the litre quantity by 5,000L increments.
3. Press  to save or press  to exit without saving.

### SETTING UP THE MINERAL TYPE (if your pool uses salt or mineral mix)

1. "START UP INFORMATION" will display on the LCD screen. "SALT" will flash.
2. Press  or  to change the type of mineral used in the pool water. Select from "SALT" or "MINERAL".
3. Press  to save or press  to exit without saving.

## 11. THE MAIN SCREEN

The Main Screen displays the current settings for the chlorinator.

**Output** = The output percentage.

**(●) symbol** = Normal operation.

**T1 or T2** = “Single Timer Cycle” or “Dual Timer Cycle” is selected.

**Mode** = ON, OFF or AUTO.

**HH:MM** = The time of day in 24 hour format.

**Cell** = Cell status (FWD, REV or OFF).

**Pump** = The status of the pool pump AC socket (ON or OFF).

**Water Temp** = Pool water’s temperature.

```
OUTPUT: 100% (●) T2
Mode:AUTO      19:49
Cell: FWD      Pump: ON
Water Temp.: 26.0 °C
```

## 12. SHORTCUT BUTTONS

Some of the menu items have shortcut buttons on the touchpad, allowing quick access without going through the main menu. The shortcut buttons are:

POWER/MODE

CLOCK/TIMER

CHLOR BOOST

SALT TEST

WINTER/BLANKET

BACK WASH

**NOTE: You must be on the Main Screen for the shortcut buttons to function.**

POWER /  
MODE

CLOCK /  
TIMER

CHLOR  
BOOST









SALT  
TEST

WINTER /  
BLANKET

BACK  
WASH

### 12.1 SHORTCUT BUTTON: POWER/MODE



This function changes the operating mode of the chlorinator. AUTO = running on the timer settings. ON = manually running, not using the timer settings. OFF = not running manually or on the timer settings.

1. Press the  button to change between AUTO, ON and OFF.
2. The mode can also be accessed via the main menu. Press the  button to enter the Main Menu. Press  or  to scroll through the menu. Press  to select Power/Mode.
3. Press  or  to adjust the power/mode.
4. Press  to save or press  to exit without saving.

### 12.2 SHORTCUT BUTTON: CHLOR BOOST







This function sets the chlorinator and pump to operate for 8 hours at 100% output, known as Chlor Boost or Superchlorination (extra sanitising time).

1. Press the  shortcut button or enter Chlor Boost via the Main Menu.

2. The cycle will automatically begin and run for 8 hours by default.
3. Press  or  to adjust the run time. You cannot use any other functions while the Chlor Boost function is running.
4. Press  to stop the cycle if needed, otherwise the chlorinator will revert back to normal settings once the cycle has finished.

## 12.3 SHORTCUT BUTTON: WINTER/BLANKET











This function reduces the chlorine output to 50% (defaults to 50% but can be modified) when the unit is either in AUTO or ON mode.

1. Press the  shortcut button or enter Winter Mode via the Main Menu.
2. Press  or  to adjust the output percentage.
3. Press  to save or press  to exit without saving.
4. “Mode: Winter” and the new chlorine output will display on the Main Screen.
5. Press the  shortcut button to turn Winter Mode off and return to 100% output.

## 12.4 SHORTCUT BUTTON: CLOCK/TIMER

This function changes the time of day (clock) and the chlorinator run times (timer).

### CLOCK SETTINGS (time of the day):



1. Press the  shortcut button or enter Clock/Timer via the Main Menu.
2. Press the  shortcut button again. “CLOCK SETTING” will be displayed on the LCD screen.
3. The hours will flash. Press  or  to adjust the hour. Press  to save.
4. The minutes will flash. Press  or  to adjust the minutes.
5. Press  to save or press  to go back to the hours. Press  again to exit without saving.









### TIMER SETTINGS (when the chlorinator will run):

Select a timer cycle and then program the times for the cycle/s. For maximum efficiency set the cycle times to run early morning and evening. To run the chlorinator in the “ON” power mode and override the internal timers, leave all timer settings as 00:00.









**Ideal Summer settings:** 6am - 10am and 4pm - 10pm (less hours for small pools, more hours for extreme weather). **Ideal Winter settings:** See Section 12.3 on page 12.

1. Press the  shortcut button or enter Clock/Timer via the Main Menu.









2. Press  to change between SINGLE CYCLE (chlorinator runs once per day) or DUAL CYCLE (chlorinator runs twice per day).
3. Press  to save the timer cycle and enter the timer program.
4. **To set the ON/START time for TIMER 1:**

“TIMER 1: ON TIME” will display on the LCD screen. The hours will flash on the LCD screen. Press  or  to adjust the hour. Press  to save. The minutes will flash. Press  or  to adjust the minutes. Press  to save and continue to Step 5, or press  to go back to the hours and repeat Step 4. Press  again to exit without saving.









5. **To set the OFF/STOP time for TIMER 1:**

“TIMER 1: OFF TIME” will display on the LCD screen. The hours will flash on the LCD screen. Press  or  to adjust the hour. Press  to save. The minutes will flash. Press  or  to adjust the minutes. Press  to save and continue to Step 6, or press  to go back to the hours and repeat Step 5. Press  again to exit without saving.

6. If you chose SINGLE CYCLE, you will be taken back to the Main Screen. If you chose DUAL CYCLE, continue to the next step.
7. **To set the ON/START time for TIMER 2:**

“TIMER 2: ON TIME” will display on the LCD screen. The hours will flash on the LCD screen. Press  or  to adjust the hour. Press  to save. The minutes will flash. Press  or  to adjust the minutes. Press  to save and continue to Step 8, or press  to go back to the hours and repeat Step 7. Press  again to exit without saving.

8. **To set the OFF/STOP time for TIMER 2:**

“TIMER 2: OFF TIME” will display on the LCD screen. The hours will flash on the LCD screen. Press  or  to adjust the hour. Press  to save. The minutes will flash. Press  or  to adjust the minutes. Press  to save and return to the Main Screen or press  to go back to the hours and repeat Step 8. Press  again to exit without saving.

## 12.5 SHORTCUT BUTTON: SALT TEST

This function measures the salt level in the pool water. **This function is a guide only.** Have your pool water tested by your local Pool Pro Professional in order to add correct













levels of salt/minerals, depending on the test results.

1. Ensure the cell is clear of calcium deposits (which may affect test results).
2. Press the  shortcut button or enter Salt Test via the Main Menu.
3. The chlorinator will run a salt test, allow at least 30 seconds for an accurate reading. The LCD screen will display the test results and any action needed to be taken.
4. The chlorinator will then return to the Main Screen automatically.

## 12.6 SHORTCUT BUTTON: BACKWASH

This function assists you in the operation of your pump and filter during a backwash.





**IMPORTANT: Never operate the filter's multi-port valve lever while the pump is running, as it may cause damage and leaking. The pump will start and stop as you require. Ensure all valves, valve handles, lids, baskets etc are in the correct positions as per the requirements of the manufacturer of the equipment.**

1. Press the  shortcut button or enter Backwash via the Main Menu. The LCD screen will display "BACKWASH MODE".
2. Rotate the filter's multi-port valve lever to the 'Backwash' position and ensure the handle locks in place. This step is not applicable for cartridge filters.
3. Press  to begin the backwash cycle. The pump will start and run for 2 minutes. A countdown timer will display on the LCD screen. Press  to increase the run time by 1 minute if desired. If you need to stop the pump during the cycle, press  to stop the pump immediately. Press  to start the pump again.
4. When the cycle has finished the pump will stop. Ensure the water in the filter's sight glass is clear, then press . The LCD screen will display "RINSE MODE".
5. Rotate the filter's multi-port valve lever to the 'Rinse' position and ensure the handle locks in place. This step is not applicable for cartridge filters.
6. Press  to begin the rinse cycle. The pump will start and run for 1 minute. A countdown timer will display on the LCD screen. Press  to increase the run time by 1 minute if desired. If you need to stop the pump during the cycle, press  to stop the pump immediately. Press  to start the pump again.
7. When the cycle has finished the pump will stop. Ensure the water in the filter's sight glass is clear, then press . The LCD screen will display "BACKWASH COMPLETED".
8. Rotate the filter's multi-port valve lever to the 'Filter' position and ensure the handle locks in place. This step is not applicable for cartridge filters.
9. Press  to confirm the filter's multi-port valve lever is set to the 'Filter' position.



10. The LCD screen will display “Final check on all valves/lid positions”. Check all other valves and lids on all equipment are in the correct position. Press the  shortcut button to finish the cycle and return to the Main Screen.

## 13. MAIN MENU

To access the main menu, press the  button and press  or  to scroll through the menu. Press  to select a menu option or press  to exit the screen. If there is no activity for more than 60 seconds in any screen, you will be taken back to the Main Screen. After 10 minutes of no activity, the LCD screen will dim. Simply press any button on the control panel to wake the screen. All menu items are:









- |                 |                |                        |
|-----------------|----------------|------------------------|
| 1 Backwash      | 6 Clock/Timer  | 11 Service Menu        |
| 2 Brightness    | 7 Contrast     | 12 Spa Mode            |
| 3 Cell Cleaning | 8 Power/Mode   | 13 Winter/Blanket Mode |
| 4 Chlor Boost   | 9 Pump Setting | 14 pH Control Mode     |
| 5 Chlor Setting | 10 Salt Test   |                        |

### 13.1 MAIN MENU: BACKWASH

See Section 12.6 on pages 14-15 (SHORTCUT BUTTON: BACKWASH).









### 13.2 MAIN MENU: BRIGHTNESS

This function adjusts the brightness of the LCD screen.

1. Press the  button to enter the Main Menu. Press  or  to scroll through the menu. Press  to select Brightness.
2. Press  or  to adjust the brightness.
3. Press  to save or press  to exit without saving.

### 13.3 MAIN MENU: CELL CLEANING

This function helps to clean calcium build-up that can occur on the cell plates.

1. Press the  button to enter the Main Menu. Press  or  to scroll through the menu. Press  to select Cell Cleaning.
2. Press  or  to adjust the frequency of the cell's cleaning cycle.
3. Press  to save or press  to exit without saving.









**In areas where the water's calcium hardness is low (less than 200ppm) cleaning of the cell may not be necessary. Where calcium levels exceed 200ppm, regular inspection of the cell is necessary. Cleaning with Pool Pro Cell Cleaner may be necessary.**

## 13.4 MAIN MENU: CHLOR BOOST

See Section 12.2 on pages 11-12 (SHORTCUT BUTTON: CHLOR BOOST).

## 13.5 MAIN MENU: CHLOR SETTING

This function controls the chlorine output of the chlorinator. Used for running the pump for longer hours (i.e. with a variable speed pump or for additional filtration).









1. Press the  button to enter the Main Menu. Press  or  to scroll through the menu. Press  to select Chlor Setting.
2. Press  or  to adjust the chlorine output percentage.
3. Press  to save or press  to exit without saving.

## 13.6 MAIN MENU: CLOCK/TIMER

See Section 12.4 on pages 12-13 (SHORTCUT BUTTON: CLOCK/TIMER).

## 13.7 MAIN MENU: CONTRAST

This function adjusts the contrast of the LCD screen.









1. Press the  button to enter the Main Menu. Press  or  to scroll through the menu. Press  to select Contrast.
2. Press  or  to adjust the contrast.
3. Press  to save or press  to exit without saving.

## 13.8 MAIN MENU: POWER/MODE

See Section 12.1 on page 11 (SHORTCUT BUTTON: POWER/MODE).

## 13.9 MAIN MENU: PUMP SETTING

This function protects the pool pump if there is no water flow. It adjusts the time that the pump runs after the cell has detected that there is no water flow.











1. Press the  button to enter the Main Menu. Press  or  to scroll through the menu. Press  to select Pump Setting.
2. Press  or  to adjust the off time of the pump (3-10 minutes). The "OFF" option disables this feature so the pump will NOT be turned off when there is no water flow. The "OFF" option is ideal for pools with a flow switch or an external pump control.
3. Press  to save or press  to exit without saving.

## 13.10 MAIN MENU: SALT TEST

See Section 12.5 on pages 13-14 (SHORTCUT BUTTON: SALT TEST).

## 13.11 MAIN MENU: SERVICE MENU









This function shows details about your Neptune Chlorinator.

1. Press the  button to enter the Main Menu. Press  or  to scroll through the menu. Press  to select Service Menu.
2. Press  or  to scroll through the following items: Model, Run Hours, Pool Size, Internal Temperature, Polarity, Output, Mineral Type, Factory Defaults, Software Version. Press  on each item to view more details. Press  to return to the list of items.
3. Press  to return to the Main Menu. Press  again to return to the Main Screen.

Contact your distributor or your local Pool Pro Professional for further information regarding the Service Menu.

## 13.12 MAIN MENU: SPA MODE

This function allows you to adjust the settings for a spa.

1. Press the  button to enter the Main Menu. Press  or  to scroll through the menu. Press  to select Spa Mode.
2. Press  or  to adjust the setting between ON or OFF.  
**ON** = 10% chlorine output. **OFF** = 100% chlorine output.
3. Press  to save or press  to exit without saving.
4. The Main Screen will display "Mode: SPA" when this function is activated.
5. Repeat these steps to turn off Spa Mode.





## 13.13 MAIN MENU: WINTER/BLANKET



See Section 12.3 on page 12 (SHORTCUT BUTTON: WINTER/BLANKET).

## 13.14 MAIN MENU: pH CONTROL MODE

This function allows you to use the Neptune pH Controller in conjunction with the Neptune Digital Chlorinator. The default setting for this function is OFF.





### To turn on the pH Control mode:

1. Press the  button to enter the Main Menu. Press  or  to scroll through the menu. Press  to select pH Control Mode.

2. Press  or  to adjust the setting between ON or OFF, then press  to save.

### **To set the run time of the pH Controller:**

The run time is programmed automatically when setting up the volume of the swimming pool in the chlorinator. The system calculates how many minutes per day your Neptune pH Controller runs based on the volume of your pool. This can be changed manually.

1. "Run Time" will flash. Press  to enter the Run Time settings. To adjust the run time press  or  then press  to save (and return to the Main Screen) or press  to exit without saving.















NOTE: Some states use undiluted acid to feed the pH Controller (i.e. there is no container with a 1:3 mix). In this case the operator needs to manually change the run time from the displayed result to an approximate 1/4 of this reading. For example if 15min/day is displayed then change this to 4min/day.

### **To set the demand or prime quantity of the pH Controller:**











The demand or prime quantity can be manually adjusted from 0-5000ml. This function is useful for priming tubes after an acid drum change, or adding the required acid from your acid demand test.

IMPORTANT: Enter the exact amount from your test result in ml (e.g. 500ml) and the system automatically adds 4 times that amount, thereby allowing for the 1:3 ACID:WATER mix ratio in the acid drum.

If you are now back in the Main Screen, go back into the pH Control Mode:

1. Press the  button to enter the Main Menu. Press  or  to scroll through the menu. Press  to select pH Control Mode. Press  or  to scroll to Demand or Prime and press .
2. Press  or  to adjust the ml quantity then press  to save. The peristaltic pump starts turning and a time-based reading starts flashing and counting down. If desired, you can lower the time by pressing  then pressing  to confirm.
3. If the tubes/lines are primed, you can stop the peristaltic pump by pressing  while in the DOSE TIME LEFT menu, until the time left reaches 0, then press  to confirm. Press  to return to the Main Screen.

### **To turn off the pH Control mode:**

1. Press the  button to enter the Main Menu. Press  or  to scroll through the menu. Press  to select pH Control Mode.
2. Press  or  to scroll until "pH Mode: ON" is flashing, then press .
3. Press  or  to select "OFF", then press  to save.



# 14. CHLORINATOR MAINTENANCE

## General Maintenance

1. Never cover the chlorinator unit with towels or similar. The chlorinator has air vents to keep it cool. Covering the vents may cause damage to the chlorinator.
2. The chlorinator should always be in an undercover area away from the elements.
3. The chlorinator should never be in a closed shed or similar environment near chemicals or fertilisers. Fumes from chemicals and fertilisers may cause damage to the chlorinator and may void the warranty.
4. Annually check all plug connections are tight and in sound condition.

## Cell Maintenance

The cell may require cleaning if it contains debris or is being used in an area with hard water. Hard water can cause calcium build-up on the cell, the sensor, or the cell plates.

1. Press the  button to OFF.
2. Switch off the chlorinator and unplug at the power point.
3. Unscrew the cell's locking ring and remove the cell's electrode.
4. Check for pool debris, especially after backwashing. Check for calcium build-up on the electrode. Do not scratch or bend the cell plates.
5. If calcium build-up is present, use *Pool Pro Cell Cleaner* to clean the cell. We do not recommend the use of Hydrochloric Acid to clean the cell.
6. Check the cell's O-Ring is clean, greased with silicone grease (never use petroleum based lubricants) and securely located in the cell housing.
7. Reinstall the cell into the housing and hand tighten the locking ring securely.
8. Plug the chlorinator into the power point and press the  button to turn the chlorinator on. The chlorinator will return to its previous settings.

## Power Pack Maintenance

1. Ensure the chlorinator is plugged into a weatherproof RCD protected 10amp outlet.
2. Ensure the pool pump is plugged into the bottom AC socket of the chlorinator unit.
3. Check all plugs and cords for damage. If any are damaged, they must be replaced by the manufacturer or a similar qualified person. If the chlorinator is hard wired, a qualified electrician is required.
4. Periodically turn the chlorinator off and apply an insect surface spray on the WALL or POST that the chlorinator is mounted to, to keep insects from entering the chlorinator unit. DO NOT spray directly into the air vents or on the chlorinator unit. Allow adequate time for the spray to dry, before turning the chlorinator back on.

# 15. TROUBLESHOOTING

| Fault Indication                       | Potential Cause  | Remedy   |
|--|--|--|
| Fault LED "ON".                        | Numerous causes.   | See the LCD screen for the reason then go to that section in this troubleshooting guide.   |
| Internal temperature high.             | No air flow around the power pack or excessively high salt.    | Ensure power pack is mounted in a well ventilated area away from chemicals and fertilisers. Check Water Balancing table (Page 6).  |
| High salt warning.                     | Salt too high or short on cell plates.                         | Check Water Balancing table (Page 6). Check the cell is clear of debris (e.g. wire, metal, touching plates, etc).  |
| Low salt or clean cell or faulty cell. | Low salt level.  | Check Water Balancing table (Page 6).  |
|  | Build-up of calcium on the cell plates.                        | Calcium build-up needs to be removed. See Cell Maintenance (Page 19).  |
|  | Water temperature is low.                                      | Winter water temperature can be very low. For every 1°C below 28°C the output can drop 2-3% .  |
|  | Insufficient water flow through the cell.                      | Ensure a full chamber of water is passing over the cell. You may need to backwash your filter. See Backwash (Pages 14-15).   |
|  | The cell could be damaged or at the end of its life.           | Damaged coating will reduce cell life and reduce output. If all conditions are correct then the cell could be at the end of its life.  |
|  | Level low in one direction but OK in the other.                | Cell may need cleaning. See Cell Maintenance (Page 19) or the cell may have run its life in one direction.   |
| Water temperature low.                 | Water temperature is below 10°C.                               | The power pack will lower output when water temperature goes below 10°C to protect the cell plates.  |
| Water temperature high.                | No water flow.   | Check for possible closed valve, pump fault, burst pipe.   |
| Water temperature sudden increase.     | No water flow.   | Check for possible closed valve, pump fault, burst pipe.   |
| Water flow fault.                      | No water flow or low water flow.                               | Air in the cell housing/water not covering the water sensor, check for closed valve, pump fault, burst pipe, etc. If none detected contact your local Pool Pro Professional for diagnosis. |
|  | Low speed pump not supplying sufficient water to cell housing. | Increase the speed of the pump until housing is filled.  |



| <b>Fault Indication</b>   | <b>Potential Cause</b>                                     | <b>Remedy</b>   |
|---|--|---|
| No current flow – no output.  | Faulty Control or Main PCB.                                | Check circuit breaker, possible faulty PCB - call for service.  |
| Everything displays OK but not turning on.                          | Incorrect timer settings.                                  | Press Power/Mode button until in ON mode. Does it work now?   |
|   | Yes, it works now.   | Check Timer Settings (Pages 12-13).   |
|   | No, it does not work.                                      | If the Fault LED is on, see LCD screen for the reason then go to that section in this troubleshooting guide. If only LCD screen is on but nothing works - call for service.                                       |
| Not operating at all - comes on but turns off.                      | Circuit breaker resets but trips again.                    | 1. Excessively high salt - check salt and lower if needed. 2. Short across cell plates - check cell plates for any metal lying across plates. 3. Faulty rectifiers, transformer or cell cable - call for service. |
| Not operating at all - no lights.                                   | Not plugged into a power point or power point is off.      | Check the power pack's power cord goes into wall outlet and outlet is turned on.  |
|   | Plugged into power point and turned on but still no power. | Test wall outlet with a working appliance.  |
|   | Wall outlet working but still no power.                    | Check circuit breaker at bottom of power pack. Press white button to reset if tripped.  |
|   | Pressed and reset but still no power.                      | If you have checked all of the above then there is an internal fault - call for service.  |
|   | Circuit breaker stays out in a tripped state.              | Faulty circuit breaker - call for service.  |
| Sign of melting or burning of the cell connector plug.              | Possible moisture entry to the plug.                       | If melted then it will need replacing otherwise clean with WD40 or similar. Return for service if melted.   |
| Power pack only works in one direction. No output in one direction. | Faulty rectifiers, transformer or PCB.                     | Return unit for service.  |
| Timer functioning incorrectly in Auto mode.                         | Incorrect settings.  | Make sure Power/Mode is set to Auto. Refer to Timer Settings (Pages 12-13).   |
| Pool pump outlet not functioning properly or pump always on.        | Pump not plugged into chlorinator.                         | Check pump is plugged into the bottom of the power pack. Check chlorinator is set in Auto mode and not Manual for normal running.   |

| <b>Fault Indication</b>   | <b>Potential Cause</b>   | <b>Remedy</b>   |
|---|--|---|
| Cell not cleaning, excessive calcium build up on cell or power pack not changing direction. | Excessively high calcium, change of direction time set too high or faulty PCB. | 1. See Calcium Hardness levels in Water Balancing table (Page 6) and adjust water accordingly. 2. Change the Cell Cleaning times (Page 15). 3. Manually try changing direction by holding both [<] and [>] buttons in for 3 seconds (you must be in the Main Screen for this to work). Failure for this to work could indicate a faulty PCB - return for service. |
| Output reading is less than 100%.   | Low salt level.  | Check salt level. See Salt Test (Pages 13-14).  |
|   | Build up of calcium on the cell plates.  | Calcium build-up needs to be removed. See Cell Maintenance (Page 19).   |
|   | Water temperature is low.  | Winter water temperature can be very low. For every 1°C below 28°C the output can drop 2-3%.  |
|   | Insufficient water flow through the cell housing.                              | Ensure a full chamber of water is passing over the cell. You may need to backwash your filter. See Backwash (Pages 14-15).  |
|   | The cell could be damaged or at the end of its life.                           | Damaged coating will reduce cell life and output. If all conditions are correct then cell could be at the end of its life.  |
|   | Level low in one direction but OK in the other.                                | Cell may need cleaning. See Cell Maintenance (Page 19) or the cell may have run its life in one direction.  |
|   | Continuous build up of calcium.  | See Cell Maintenance (Page 19).   |
| Low or no chlorine output.  | Unit not working correctly.  | Go through Troubleshooting from the beginning.  |
|   | Unit not set correctly.  | Check basic settings such as output control and timer running hours. Go through all settings on Pages 11-18 and balance water accordingly.  |
|   | Salt level is too low.   | Check Salt in the Water Balancing table (Page 6).   |
|   | pH is too high.  | Check pH in the Water Balancing table (Page 6).   |
|   | Stabiliser is too low.   | Check Stabiliser in the Water Balancing table (Page 6).   |
|   | Cell at the end of its life.   | If full output is not reached then it could be a failing cell.  |
| Timer loses time when mains power removed.  | Battery life expired.  | Replace battery - return for service.   |



| #  | CODE       | DESCRIPTION  |
|----|------------|--|
| 1  | NDC15PP    | 15g Power Pack   |
| 1  | NDC25PP    | 25g Power Pack   |
| 1  | NDC35PP    | 35g Power Pack   |
| 1  | NDC45PP    | 45g Power Pack   |
| 1  | NDC55PP    | 55g Power Pack   |
| 2  | PPN00895   | Neptune Wire Loom-Multi PCD TB-GND Pin 1 to LCD PCB<br>RB-GND Pin 1 Black    |
| 3  | PPN00364   | Front Case   |
| 4  | PPN00365   | Top Vent Cover   |
| 5  | PPN00367   | Front Flap   |
| 6A | PPN00437-2 | Front Decal Sticker  |
| 6B | PPN00437-1 | Touchpad Membrane  |
| 7  | PPN00693   | Multi Triac Main PCB   |
| 8  | PPN00496   | LCD Display PCB  |
| 9  | PPN00356   | Aluminium Base   |
| 10 | PPN00453-2 | Mounting Bracket   |
| 11 | PPN00024-1 | Transformer 440VA (45/55g)   |
| 11 | PPN00023-1 | Transformer 300VA (25/35g)   |
| 11 | PPN00022   | Transformer 220VA (15g)  |
| 12 | PPN00498   | AC Socket Round - Pump Outlet Flush Mount White (Side<br>Wire Entry)         |
| 13 | PPN00869   | Cable Grommet 6N-4   |
| 14 | PPN00501   | Grommet Rubber Aux Hole Up To 19mm   |
| 15 | PPN00488   | Cell Plug SL-10 Male End Complete With Power Supply<br>Looms - Grease Filled |
| 16 | -          | Neptune Screw Stainless M3 x 12 S/S (Fan)                                    |
| 17 | PPN00018L  | Circuit Breaker 91L-Series 3A (15/25/35/45g)                                 |
| 17 | PPN00019-2 | Circuit Breaker 91L-Series 5A (55g)  |
| 18 | PPN00053-1 | Mounting Bracket Screw 4mm x 16 S/S  |
| 19 | PPN00368   | Bottom Vent Cover  |
| 20 | PPN00369   | Fan Support Plate  |
| 21 | PPN00370   | Snap Fit Gauze   |
| 22 | PPN00478   | Earth Screw M5 S/S   |
| 23 | PPN00051   | Earth Nut M5 S/S   |
| 24 | PPN00049   | Internal Tooth Washer For Earth M5 S/S                                       |
| 25 | PPN00011   | Power Cord-AU  |
| 26 | PPN00323   | Fan 40x40x10mm (55g)   |
| 27 | PPN00027-2 | Thermostat 100°C   |
| -  | PPN00047   | Neptune Washer - 37x37x2.5 Zinc Plated                                       |
| -  | PPN00207   | Neptune Wire Loom - Circuit Breaker Load to Thermostat Brown                 |
| -  | PPN00223   | Neptune Wire Loom - AC Socket N to PCB N Blue                                |
| -  | PPN00224   | Neptune Wire Loom - AC Socket L to PCB PUMP-L Brown                          |

|    |                  |  |
|----|------------------|--|
| -  | PPN00348         | Neptune Wire Loom - Circuit Breaker LINE to PCB A Brown                  |
| -  | -                | Neptune Wire Loom - Terminal Block 1 Pin 2 to Terminal Block 2 Pin 2 Red |
| 36 | PPN00485         | Neptune Ribbon Cable with Red line and Header Sockets                    |
| -  | PPN00008         | Wire Loom CC-05 - Earth Wire CPP/CPPS/Neptune Models                     |
| -  | PPN00036         | CPP/CPPS/Neptune Cable Tie 3mm   |
| -  | PPN00560         | CPP/CPPS/Neptune Green Wall Plugs  |
| -  | PPN00217         | CPP/CPPS/Neptune Screws Wall SS 5x25                                     |
| -  | PPN00053-1       | Neptune Screw Stainless M4 x 8 S/S (Front Cover)                         |
| -  | PPN00052         | Neptune Screw Stainless M3x6 S/S (SCR/Triac Connection & PCB)            |
| 61 | PPSL-CELL15RP    | 15g/hr Cell Only   |
| 61 | PPSL-CELL25RP    | 25/hr Cell Only  |
| 61 | PPSL-CELL35RPB   | 35g/hr Cell Only   |
| 61 | PPSL-CELL45RPB   | 45g/hr Cell Only   |
| 61 | PPSL-CELL55RPB-C | 55g/hr Cell Only   |
| 62 | PPN00379         | 3-Way Cell Housing - Smokey  |
| 63 | OR950M           | Cell Housing NDC O-Ring EPDM Rubber                                      |
| 64 | PPN00380         | Cell Cap Locking Ring NDC  |
| 65 | PPSCCAP          | Cell Cap (Includes Cable, Cover, Cap, Brassware, Washers, Resin Filled)  |
| 66 | PPN00530         | Cell Clip 11 Plate Blue (15/25g)   |
| 66 | PPN00666-2       | Cell Clip 15 Plate Blue (35/45/55g)                                      |
| 67 | PPN00322         | Cell Spacer Rod Blue   |
| 67 | PPN00260         | Cell Spacer Rod Black  |
| 68 | PPN00691-1       | Cell Blanking Bush   |
| 69 | OR941M           | Cell Adapter Tail O-Ring   |
| 70 | PPN00382         | Cell Adapter Tail  |
| 71 | PPN00381         | Cell Nut Small   |
| 72 | PPN00670-1       | PVC Reducing Bush 50x40mm  |

## 17. CHLORINE PRODUCTION SPECIFICATIONS

| Model   | Chlorine Output | Cal. Hypo. Equivalent (65%) | Sod. Hypo. Equivalent (12.5%) | Chlorine Output | Cal. Hypo. Equivalent (65%) | Sod. Hypo. Equivalent (12.5%) |
|---------|-----------------|-----------------------------|-------------------------------|-----------------|-----------------------------|-------------------------------|
|         |                 | PER HOUR                    |                               |                 | OVER 8 HOURS                |                               |
| NDC15   | 15g             | 23g                         | 120ml                         | 120g            | 184g                        | 0.96L                         |
| NDC25/C | 25g             | 38g                         | 200ml                         | 200g            | 304g                        | 1.60L                         |
| NDC35/C | 35g             | 54g                         | 280ml                         | 280g            | 432g                        | 2.24L                         |
| NDC45/C | 45g             | 69g                         | 360ml                         | 360g            | 552g                        | 2.88L                         |
| NDC55C  | 55g             | 85g                         | 440ml                         | 440g            | 680g                        | 3.52L                         |

## 18. TECHNICAL SUPPORT

For product support contact your local distributor or Pool Pro directly by emailing [service@poolpro.com.au](mailto:service@poolpro.com.au). Installations and repairs should only be carried out by qualified persons or Pool Pro appointed agents. Pool Pro reserves the right to refuse warranty if any damage caused to the chlorinator or auxiliary pool equipment that is not a result of a manufacturer's defect.

## 19. WARRANTY

**1:** Pool Pro warrants the Neptune Digital Salt and Mineral Chlorinator range (domestic models) only for the original purchaser and is non-transferable. Pool Pro warrants the power pack and cell to be free of manufacturer's defects in materials and workmanship for a total period of four (4) years or up to 10,000 hours (whichever comes first) from the date of original purchase; commercial models are warranted for a period of four (4) years or up to 15,000 hours (whichever comes first) from the date of original purchase; should it be found, after examination, that the failure has been caused by faulty workmanship or materials. This is a back to base warranty.

**2:** Adverse operating conditions beyond the control of the manufacturer such as improper voltage or water pressure, excessive ambient temperature or any condition that adversely affects the performance of the equipment will render this warranty null and void.

**3:** Defective equipment must be returned to the manufacturer or dealer as soon as the purchaser becomes aware of the defect and all transport must be prepaid. Neither the manufacturer nor the dealer shall be responsible for any goods damaged in transit.

**4:** If after examination the equipment is found to be defective it will be repaired or replaced free of charge (other than transport costs which will be borne by the purchaser). However, if upon inspection of the equipment it is found that the terms of this warranty are not satisfied, then the usual charges of the manufacturer for repair or replacement will be made.

**5:** Any liability of the manufacturer pursuant to the Trade Practices Act 1974, as amended for a breach of a condition or warranty shall be limited to replacing or acquiring the equipment (or part thereof) where the same has been supplied.

**6:** The maximum liability incurred by the manufacturer shall not in any case exceed the contract price for the equipment or the product parts or components thereof claimed to be defective. Further, the manufacturer shall not be liable for any loss, damage or delay directly or indirectly caused by any malfunction of or defect of or failure of the equipment other than as expressly provided in this warranty.



**7:** Products sold by the manufacturer are designed for use with swimming pool water balanced in accordance with the Langelier Saturation Index (AS 3633-1989) with a pH range of 6.8-7.8. The chlorine level should not exceed 4ppm and the salt level should not exceed 4500ppm.

**8:** The manufacturer will not be held liable for damage caused by, but not limited to, corrosion, scaling or stress.

**9:** This warranty is applicable to workmanship and materials only.

**10:** This warranty is not transferable under any circumstance.

**11:** Extended periods to gain more chlorine production voids the Warranty.

**12:** Keep your original purchase invoice and serial number in a safe place.

**13:** Visit [www.poolpro.com.au/serviceclaim](http://www.poolpro.com.au/serviceclaim) to submit a warranty request.

The warranty is void under the following circumstances:

- Installation is carried out incorrectly by any person other than a person authorised by us to do so.
- The Power Pack or Cell is serviced by any person other than a person authorised by us to do so.
- Correct salt levels are not maintained at all times.
- The Power Pack is not protected from the elements.
- The Power Pack is not operated in a position/area with good ventilation.
- Water has been allowed to enter the Power Pack or Junction Box.
- Insect infestation or penetration by dust, sand or other foreign particles inside the Power Pack.
- Damage beyond our control.
- Equipment that has been misused, neglected, damaged, repaired without authorisation or altered in any way.

## 20. PRODUCT REGISTRATION

Please register your product online at [www.poolpro.com.au/product-registration](http://www.poolpro.com.au/product-registration) within 30 days from date of purchase, or any warranty claim may be voided.

More products in the Neptune range...

**PUMPS | FILTERS | CHLORINATORS | CLEANERS | LIGHTS**

**Neptune**  
for swimming pools

By **Pool  
Pro**

